

Burglary resistant safes

Unyielding and unmatched security for your valuables with a strong double-walled construction that offers resistance against burglars and fires.

Defender Prime

Strong, secure and affordable



The high end Godrej Defender Prime Safe will be the first of its kind from the house of Godrej. The Defender Prime is designed on a platform suited to the needs of consumers across the globe, thus bringing international quality and looks for our Indian customers. The Defender Prime is the solution to the customers' needs against all possible burglary attacks. Reinforced with enhanced barrier material (DDB and TDR), developed by Godrej through rigorous research and development, it now offers excellent resistance to threats which include cutting, breaking and drilling using all types of mechanical and electrical tools. E.g. - Oxyacetylene torch, crowbars etc.

Features



BIS Certified Safes
Tested as per BIS standard IS: 550



BIS Standard Tested
Type A amplified 8 lever dual control
Godrej key locks - IS: 17566



Strong Shooting Bolts
To secure the door behind the jamb box
against dislodging



Dual Control High Precision
8-lever locks protected with unique drill-
defeat shield in the door



**Two-Step Door and Frame
Construction**
For higher resistance against fire and
burglary



Torch and Drill Resistant Matrix
Enhanced Torch and Drill Resistant
Matrix used in TRTL classes of safes
(Class BB and above)



Lift-off Hinges Door Construction
Facilitates removal of the door for ease
of transportation and service



Additional Beta Relocker
Sets the safe into a deadlock with two
relockers and an additional beta relocker
to protect from precision attack on the
lock



Double Duty Barrier (DDB)
Armoured with Double Duty Barrier
(DDB) material in the door and the body



Strong and Seamless Body
With fully welded multi-corner bend
construction without a single rivet and
one-piece wrap around door
construction

Specifications

Models	Class C (TL 30 D x TL 10 x 5 – FR 30)		Class BB (TRTL 15 x 6)		Internal(H x W x D) (cm)
	External (H x W x D) (cm)	Weight (kg)	External (H x W x D) (cm)	Weight (kg)	
26	65.2 x 52.1 x 57	448	70.2 x 57.1 x 62.4	640	46.2 x 33.1 x 28.8
31	77.8 x 62.3 x 66	632	82.8 x 67.3 x 71.4	900	58.8 x 43.3 x 37.8
41	103.2 x 62.3 x 66	785	108.2 x 67.3 x 71.4	1160	84.2 x 43.3 x 37.8
49	123.6 x 77.5 x 72	1157	128.6 x 82.5 x 77.3	1680	104.6 x 58.5 x 43.6
61	154.1 x 77.5 x 72	1382	159.1 x 82.5 x 77.3	2050	135.1 x 58.5 x 43.6

Important:

- Please check the load carrying capacity of the floor from structural engineers, if the safe is to be kept on the first floor or above. Place the safe preferably on a beam.
- All dimensions are in cm.
- Tolerance - Weight +10 /-5 % or as per applicable standard, Dimensions – As per applicable standard.



Specifications

Models	Class A (TRTL 30 x 6)		Class AA (TRTL 60 x 6)		Internal (H x W x D) (cm)
	External (H x W x D) (cm)	Weight (kg)	External (H x W x D) (cm)	Weight (kg)	
26	76.2 x 63.1 x 66.2	*	70.2 x 57.1 x 62.4	691	46.2 x 33.1 x 28.8
31	88.8 x 73.3 x 76.4	*	82.8 x 67.3 x 71.4	994	58.8 x 43.3 x 37.8
41	114.2 x 73.3 x 76.4	*	108.2 x 67.3 x 71.4	1239	84.2 x 43.3 x 37.8
49	134.6 x 88.5 x 82.3	2197	128.6 x 82.5 x 77.3	1759	104.6 x 58.5 x 43.6
61	165.1 x 88.5 x 82.3	2574	159.1 x 82.5 x 77.3	2109	135.1 x 58.5 x 43.6

Specifications

Models	Class AAA (TRTL 90 x 6)		Internal (H x W x D) (cm)
	External (H x W x D) (cm)	Weight (kg)	
41	112.2 x 71.3 x 75.5	1475	84.2 x 43.3 x 37.8
49	132.6 x 86.5 x 81.3	2080	104.6 x 58.5 x 43.6
61	163.1 x 86.5 x 81.3	2540	135.1 x 58.5 x 43.6

Important:

- Please check the load carrying capacity of the floor from structural engineers, if the safe is to be kept on the first floor or above. Place the safe preferably on a beam.
- All dimensions are in cm.
- Tolerance - Weight +10 / -5 % or as per applicable standard, Dimensions – As per applicable standard.

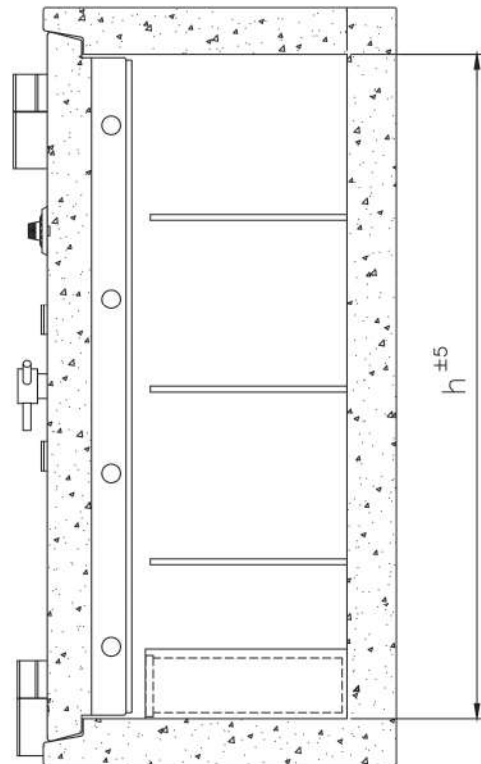
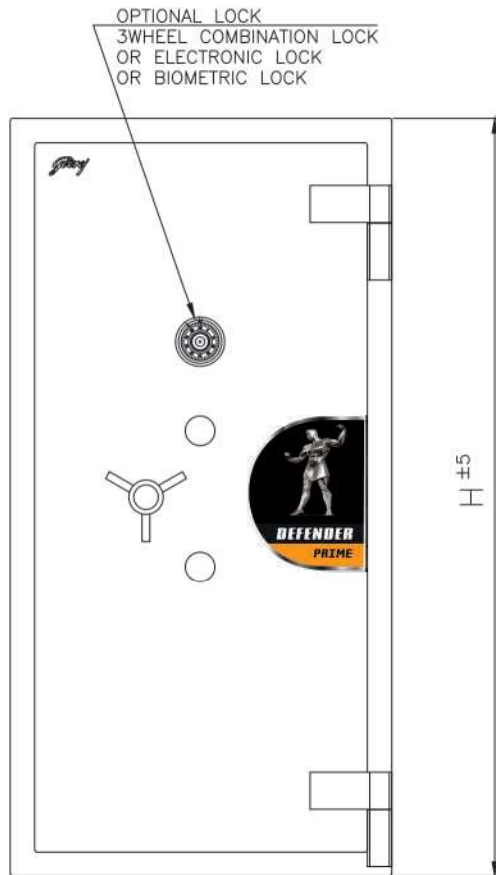
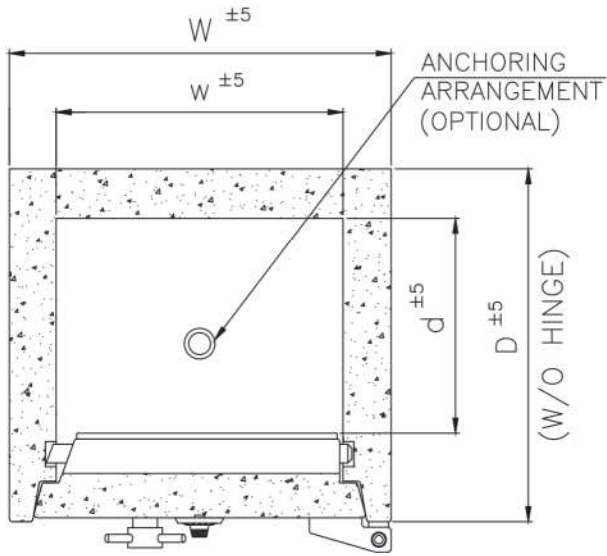

Defender Prime Double Door Safes

Designed to fit your security concerns

Defender Prime Double Door Safes are expertly designed to meet your security needs. With rising threats and advanced tools making intrusions more likely, the need for superior security has never been more urgent.

Our Defender Prime Double Door Safes are built to withstand even the most advanced attacks, offering robust protection for your business to protect their valuables while maintaining an attractive display.



Features



BIS Certified Safes

Tested as per BIS standard IS: 550



BIS Certified

Type A amplified 8 lever dual control Godrej key locks – IS: 17566



Strong Shooting Bolts

To secure the door behind the jamb box against dislodging



Dual Control High Precision

8-lever locks protected with unique drill-defeat shield in the door



Two-step Door and Frame Construction

For higher resistance against fire and burglary.



Additional Beta Relocker

Sets the safe into a deadlock with relockers and an additional beta relocker to protect from precision attack on the lock



Double Duty Barrier (DDB)

Armoured with Double Duty Barrier (DDB) material in the door and the body



Strong and Seamless Body

With fully welded multi-corner bend construction without a single rivet.



49 DD



61 DD



84 DD



88 DD

Class C (TL 30 D x TL 10 x 5 – FR 30)

Model No.	External Dimensions (h x w x d) (cm)	Internal Dimensions (h x w x d) (cm)	Net Weight (kg)	Volume (L)
26 DD	66.2 x 106.2 x 56.7	46.2 x 86.2 x 29.5	840	118
31DD	78.8 x 126.6 x 66.7	58.8 x 106.6 x 39.5	1230	248
41DD	104.2 x 108.9 x 66.7	84.2 x 88.9 x 39.5	1390	297
49DD	124.6 x 108.9 x 71.6	104.6 x 88.9 x 43.8	1600	409
61DD	155.1 x 108.9 x 71.6	135.1 x 88.9 x 43.8	2060	530
84DD	212.5 x 130.4 x 87.3	192.5 x 110.4 x 59.5	3250	1265
88DD	222.5 x 133 x 91.2	202.5 x 113 x 62.5	3535	1430

Important:

- Please check the load carrying capacity of the floor from structural engineers, if the safe is to be kept on the first floor or above. Place the safe preferably on a beam.
- All dimensions are in cm.
- Tolerance - Weight +10 /-5 % or as per applicable standard, Dimensions – As per applicable standard.

Defender Prime Neutronics

Intelligent security, uncompromised protection



Godrej Defender Prime Neutronics is a next-generation 'Intelligent' safe that offers advanced technological features alongside its time-tested physical strength.

Designed to deter, detect, delay, defend, and deny, the Defender Prime Neutronics safe utilizes cutting-edge technology to safeguard itself against the most sophisticated modern-day attacks. This intelligent safe can quickly sense a threat, alerting you while simultaneously defending itself with built-in technological reinforcements.

Intelligent security that's way ahead

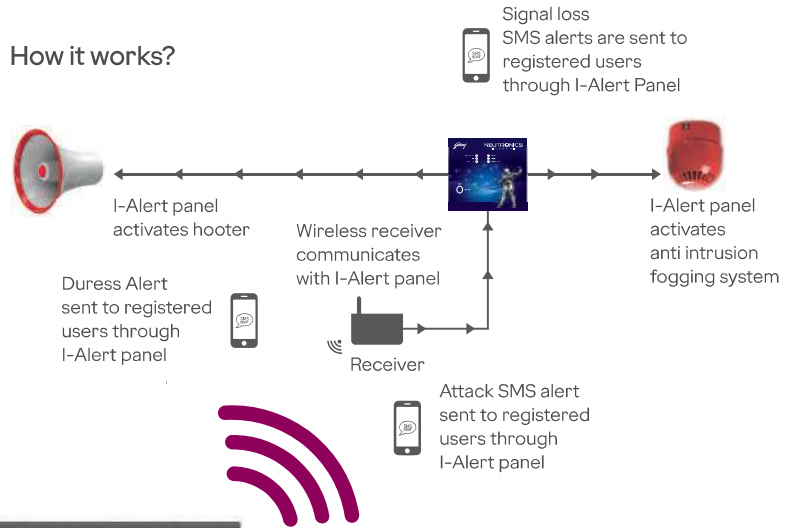

Features



BIS Certified Safes

Tested as per BIS standard IS: 550



Duress* (SOS)

In the event of a distress situation, it sends a silent alarm to registered users.



Double Duty Barrier

This feature provides resistance against burglary attacks and renders the safe fire-resistant.



Ease of Transportation

The lift-off hinges door construction facilitates the removal of the door for ease of transportation and servicing.



Torch & Drill Resistance Matrix**

This feature provides resistance to combat modern-day torch and tool attacks.



BIS Certified

Type A amplified 8 lever dual control Godrej key locks - IS: 17566



Lock Integration* (Biometric/electronic lock)

- Grants access to up to 30 authorized users.
- Records a time and date-stamped audit trail.
- Offers dual-mode authorization.
- Includes a time delay feature (1-99 minutes) to deter unauthorized access.



Automatic Relocking Device

In the event of an attack on the lock, this device sets the safe into a deadlock, ensuring its security.



High Precision Locks

The 8-lever dual-control brass locks offer a high number of combinations and massive resistance against pilferage.



Xshield

This is an advanced form of security against burglar attacks on locks, in addition to automatic relocking.



I - Alert

In the event of a burglary attempt, the safe is equipped to trigger a local alarm via a hooter and send alerts to up to eight registered phone numbers.

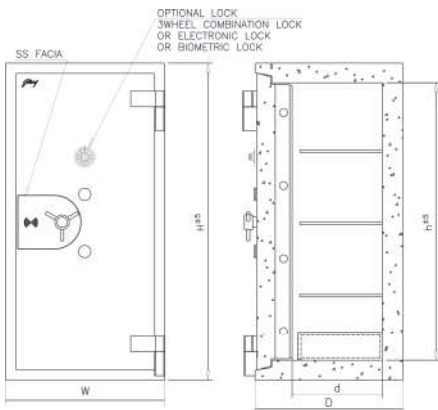

Specifications

Models	External Dimensions			Internal Dimensions			Volume (L)	Weight (kg)
	Height	Width	Depth	Height	Width	Depth		
61-CLASS C	154.1	77.5	72	135.1	58.5	43.6	344	1384
61-CLASS BB	159.1	82.5	77.3	135.1	58.5	43.6	344	2050

Please note:

All dimensions in cm.

Also 26 to 81 sizes in all classes are available as per order. *Available only in Electronic & Biometric Lock Type.

**Class BB & above.

Important:

Please check the load carrying capacity of the floor from structural engineers if the safe is to be kept on the first floor or above. Place the safe preferably on a beam. Tolerance: Weight: $\pm 10\%$, Dimension: $\pm 5\%$.

Dynamic Innovation

Discover a realm of advanced security solutions, where innovation meets intelligence, safeguarding your world with next gen advanced technology and instant alarms

Catch the intruder by surprise



Godrej Smart Fog

Anti-intrusive fogging system with instant alarm, to fog out the intruder.



In an age of cybercrimes and internet banking, even a burglar can attempt to act as clever as a smart device. So, how can you outsmart an intruder?

The Godrej Neutronics Self Defender is a compact yet powerful fogging security system that can confuse any intruder. A motion sensor detects break-ins and triggers the gas diffuser to emit the densest fog. It can cover up to 600 m³ in under 30 seconds.

While the foggy conditions last for 30–40 minutes, the low visibility causes burglars to abandon their plans and leave the premises as quickly as possible. This Godrej Neutronics Self Defender anti-intrusive fogging modular system is also WiFi-enabled.



Features



Compact lightweight cabinet with special heating system of liquid less than 2 hours



Single shot coverage of 600 m³



In 28 Sec an entire room of 600 m³ is covered



200 m³ of less than 1 m visibility



Shot characteristics are programmable in sec as per requirement



Total discharge capability with full bag of 500 ml is 850 m³



Over 1 hour of operating power without main power

Defender Safe With Safe Deposit Locker Cabinets



Godrej Safe Deposit Locker Cabinet gives you the advantage of a vault room combined with safe deposit locker facilities.

The Safe deposit lockers cater to the varying needs of bankers and provide various sizes of lockers in different combinations of all three models of Godrej Defender Plus Safes - 61 with 29 lockers, 81 with 36 lockers, 46, 56 and 84 with 90 lockers.

Specifications

Models	Number of Lockers in Each Type									Overall Dimensions		
	A	A1	B	C	D	D1	E	F	F1	Height (cm)	Height (cm)	Height (cm)
61 Def Plus Safe with 29 Lockers	-	27				2				154.1	77.5	72
81 Def Plus Safe with 36 Lockers	24			8				2	2	204.5	95	87.3
81 Def Plus Safe with 46 Lockers	40			4				2		204.5	95	87.3
81 Def Plus Safe with 56 Lockers	56									204.5	95	87.3
84 Def Plus Safe with 90 Lockers	90									212.5	130.4	87.3

All dimensions are in cm and tolerance - dimensions $\pm 5\%$
 *Customised Locker configuration can also be offered

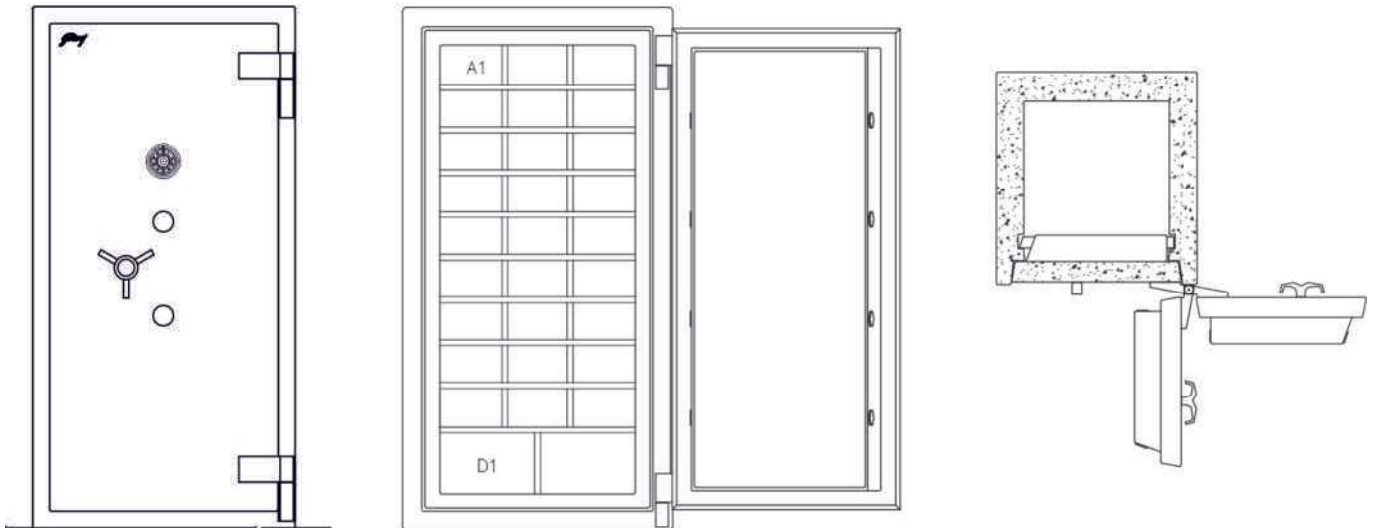

Elevation Door Open at 180°

Safe with Key Detent Mechanism Drawer

Ultimate security elevating protection
to unmatched levels



In your bank, the security of customer valuables and cash is of paramount importance, and a safe plays a key role in ensuring this security. To align with your bank's high standards, Godrej Safe is equipped with an advanced Key Detent Drawer Mechanism, delivering on that commitment. This innovative system significantly prolongs the burglary process during key extraction, creating a formidable barrier against unauthorized access. Unlocking the safe requires a sequential process of opening and closing a drawer to retrieve the key. The additional time and effort demanded by this mechanism effectively discourage potential intruders, enhancing the protection of your valuables to unparalleled levels.

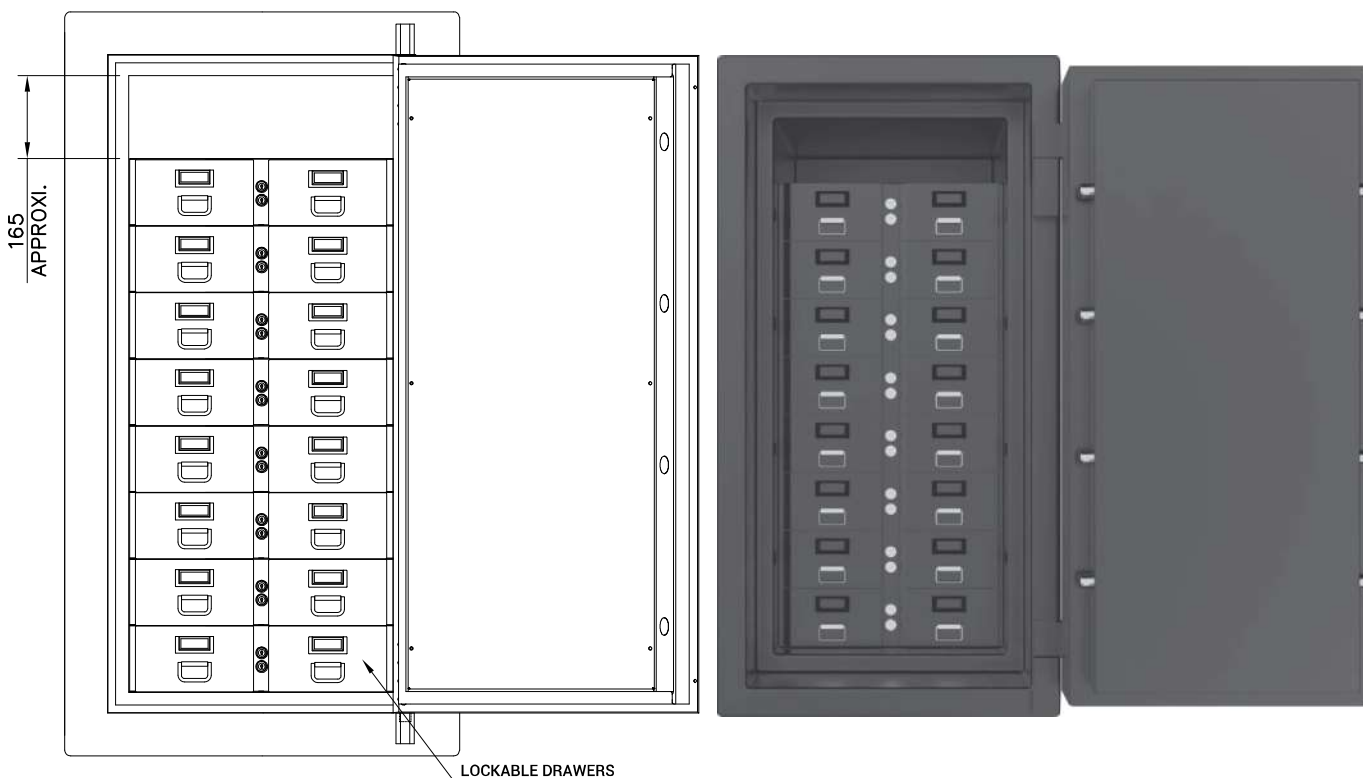

Specifications - Class - C

Safe Type	Internal Size of Safe (H X W X D) (cm)	Internal Size of Drawers (H X W X D) (cm)
41 with 10 KDM drawers	84.2 x 43.3 x 37.8	10.5 x 17 x 32.5
49 with 12 KDM drawers	104.6 x 58.5 x 43.8	11 x 25 x 34
61 with 16 KDM drawers	135.1 x 58.5 x 43.8	11 x 25 x 34

Important:

- Please check the load carrying capacity of the floor from structural engineers, if the safe is to be kept on the first floor or above. Place the safe preferably on a beam.
- All dimensions are in cm.
- Tolerance - Weight +10 / -5 % or as per applicable standard, Dimensions - As per applicable standard.

Currency Bin Cabinet

Minimizing transport, maximizing storage

In the era of smart banking, you need smart currency handling. Godrej Currency Bin minimises the need for transportation and maximises the storage of currency while providing adequate convenience in the vault room.

They have been designed to maximise storage capacity available keeping in view the common sizes and configuration of the strong rooms

Two highly precision 6-lever locks, a hasp and a staple provide additional security.

“Unique flag indicator” is an exceptional feature providing a visual indication of whether the cabinet is locked or not thereby ensuring safety.



Features



Fitted with Two Highly Precise Locks

A hasp and a staple are also provided for additional security



Designed to Maximize Storage Capacity

Available keeping in view the common sizes and configuration of the strong rooms



Unique Flag Indicator

That indicates whether a cabinet is locked or not

Specifications

Currency bin cabinets	6 BINS	4 BINS	4 BINS (SPECIAL)
Height (cm)	147.2	99	99
Width (cm)	183	183	101.6
Depth (cm)	76	76	76

All dimensions are in cm and Tolerance - dimensions $\pm 5\%$

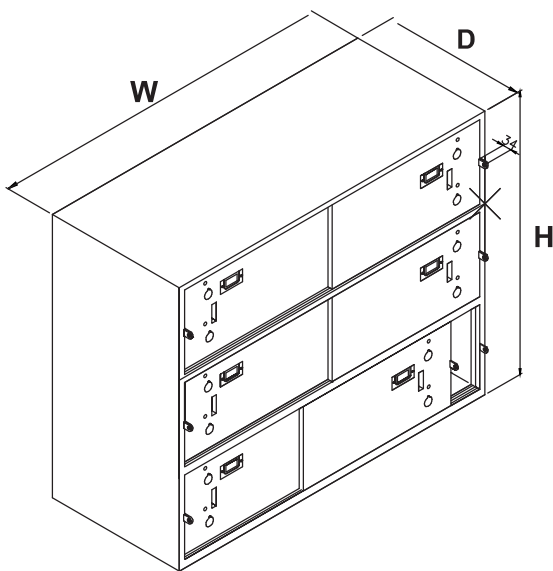

**6 Currency
Bin Cabinet**

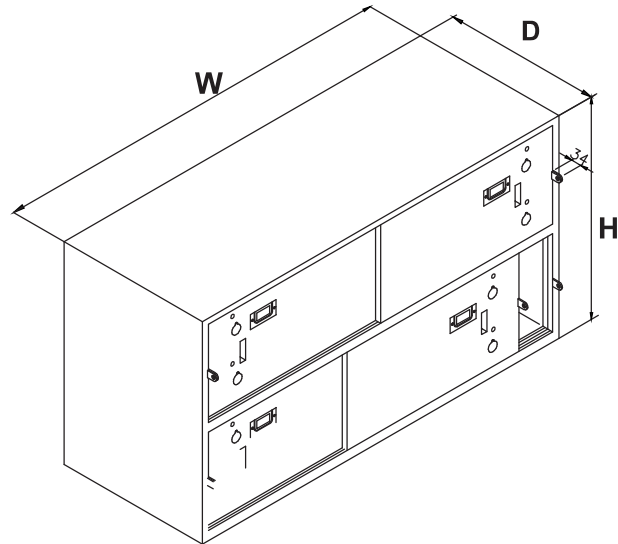

**4 Currency
Bin Cabinet / 4 Currency
Bin Cabinet (SPL.)**

Burglary Resistant Strong Room Doors

Fortified protection, precision engineering,
and unrivalled defence, guarding your assets
with impenetrable strength and confidence

Strong Room Door

Drill machine and oxy-acetylene torch resistant

High volumes of cash and valuable transactions demand high-end security measures. Godrej Security Solutions' state-of-the-art Strong Room Doors are made with double-duty barrier material and a torch and drill matrix to provide superior resistance against attacks by drill machines, oxy-acetylene torches, and more.

The doors come fitted with two dual-control high-precision locks, as well as automatic relocking deadlocks. The Strong Room Doors are specially designed for banks, financial institutions, jewelers, and other high-turnover businesses.



Clenching Mechanism

Features



BIS Certified

Tested as per BIS standard IS 11188.



A Unique Two Step Door Construction

For higher resistance against fire and burglary.



Godrej Double Duty Barrier

Material provides reliable protection against fire



12 Shooting Bolts

Each of 38 mm diameter are provided in front and rear to secure the door



Balanced Pressure Bolt

To protect against dislodging attempt by creating equal neutralizing pressure from within



Impact Resisting Shaft

For handle to resist break in



Locks and Re-locking Devices

Protected by specially designed drill-defeat shield



Automatic Re-locking Device

Deadlocks the door in case of explosives or mechanical attacks



Additional Re-locking Device

On primary lock for extra protection



Grille Gate

Secured with high-precision 8-lever lock, and opens on both sides



Dual Control High Precision

8-lever locks protected with unique drill-defeat shield in the door



A Relay Micro Switch

Provided inside to control the lighting inside the vault room



Superior Quality

10 mm thick MS door frame



Torch and Drill Resistant Matrix

Enhanced Torch and Drill Resistant Matrix used in TRTL classes of safes (Class BB and above)

The materials used in the product are Green Pro certified.

Specifications

Specification	Nomenclature	Class-C	Class-B
Overall Size (cm)	H*W	212.8 * 122	212.8 * 125.4
Clear Opening (cm)	H*W	195.3 * 91	195.3 * 91
Thickness of door with lock case (cm)	T	17.2	19.2
Overall door thickness including frame and grill gate (cm)	OT	30	30
Recommended for wall thickness (cm)	WT	30.5-38	30.5-38
Door swing (cm)	B	106	106
Grille gate swing (cm)	C	99	99
Projection of door when opened at 90 (cm)	D	108	108
Projection of door when opened at 180 (cm)	E	27.5	29.5
Overall width of door and frame for max clear opening (cm)	F	185	186.7
Overall width of door and frame for when fully opened (cm)	G	220.5	222.4
Approx. weight (kg)		860	965

*Locking Mechanisms are also available in (a) Combination Lock (b) Electronic Lock © Biometric Lock (d) Time Lock

All dimensions are in cm and Tolerance - dimensions $\pm 5\%$

Pilfer Proof Safe Deposit Lockers

Superior security, seamless access, and unwavering confidence, safeguarding your treasures with utmost confidentiality and trust.

Autovault Automated Safe Deposit Lockers

Next gen security for next gen banking

Worldwide mergers and boardroom handshakes build bank equity. Godrej, in association with ITOKI Corporation, JAPAN, is all set to make its mark with cutting-edge technology and completely revolutionize your customer locker usage experience. Introducing Autovault - Automated Safe Deposit Lockers, equipped with next-generation technology that allows customers to access their belongings anytime, hassle-free. Autovault represents the pinnacle of locker technology, bringing convenience to a level that was previously only imaginable.



Features



10 Locker sizes available



Modular design



Compatible with different types of safe deposit boxes



Flexibility in layout to maintain customer privacy and security



An option for incorporating a maximum of 4 operation booths for one system



Option of changing the safe deposit locker box size after installation for maximizing occupancy

Benefits to bankers

- Does not need a custodian to operate the lockers
- No manual Intervention required
- A premium service that will lead to higher revenues on account of higher rent. Highly compact in terms of locker to space ratio
- 10 different locker sizes to target diverse customer requirements
- Highly customizable lockers where non-moving lockers can be replaced with in-demand lockerseven after installation

Benefits to customers

- Round-the-clock access and quick retrieval times
- Access in pleasant air-conditioned booths to enhance convenience and privacy
- Customers can access their lockers simultaneously by provisioning for upto 4 separate booths thus cutting waiting time
- The locker comes to the customer in the booth without the inconvenience of accessing the top and bottomrow lockers
- Robotic technology provides high accuracy and reliability



How autovault works

1.



1st Layer of Security

A unique access card enables entry into the locker booth

2.



2nd Layer of Security

Insert the card in the card slot

3.



3rd Layer of Security

key in your 4 digit secret pin code on the LCD panel

4.



4th Layer of Security

Use your unique finger identification to access the locker

5.



5th Layer of Security

Use your unique key to the locker

Secunex Next gen Safe Deposit Lockers

Innovation enriching convenience

Valuables are closest to the hearts of your customers. Give them the security they deserve. Godrej SECUNEX Safe Deposit Lockers are the most thoughtful lockers available. They are equipped with unique features and complementary innovative accessories that ensure maximum convenience for you. The small touches added at every step provide that extra sense of comfort, enriching your locker usage experience.



Available in 2 visually appealing colours

• Champaign Gold • Steling Silver

Features



BIS Certified

Tested as per BIS standard IS: 5244



High Quality Steel

For unmatched strength



High Quality Steel Structure

Unmatched strength 10 mm thick solid steel door for enhanced protection



High Precision Lock

Unpickable, dual-control 7-lever lock



Renter's Personal Lock Built in 6 Lever Lock (as per the customer's requirement)

This special lock is provided with a unique key for ensuring additional security

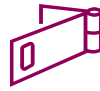

A Padlocking Hasp

Can be fitted on all locker doors to enable the renters to use their own padlock beside rendering additional security to the door



Available with independent standard lockers of 10 different sizes



Available in 2 Different Fascia Options

Sterling Silver, Anodized Gold

Exclusive features of secunex safe deposit locker



Intellilight

An advanced LED light, which gets activated on detecting motion, the magnetic back of the light enables the user to place it anywhere inside the locker to gain better visibility into deep recesses



Secunex keychain

A distinctive keychain for quick access and easy visibility



Memory log with pen

Complimentary with every SECUNEX locker, this diary lets your customer maintain an inventory of the valuables stored



Inspection Table



Step Ladder



Low Settee



Renter's Personal Lock



Secunex Safe Deposit Lockers



Masterminded by Godrej Secure Vault Manager

Safe Deposit Locker Cabinets

Stringent specifications for superior strength

Uncompromising banking deserves uncompromising security. Godrej Safe Deposit Locker Cabinets are designed to the most stringent specifications, quality standards and rigidly controlled manufacturing processes. Resulting in cabinets that are superior in all aspects – security, reliability, strength and aesthetics. Godrej SDLC's are available in 10 different locker types and there are over 1600 configurations.



Features



BIS Certified

Tested as per BIS standard IS: 5244



High Quality Enamel Paint Coating

Oven-baked under controlled conditions for scratch resistant finish



BIS certified locks

Type B amplified 7 lever dual control
Godrej Keylocks - IS - 17566



Available with independent lockers
of 10 different sizes



High Quality Steel Structure

For unmatched strength



A Padlocking Hasp

Can be fitted on all locker doors to enable the renters to use their own padlock beside rendering additional security to the door



Renter's Personal Lock Built in 6 Lever Lock (as per the customer's requirement)

This special lock is provided with a unique key for ensuring additional security



State-of-the-art twelve-tank anti-corrosion treatment for all steel components



Locks Protected by a Solid Steel Door

With no part protruding out

Technical Specifications

Locker type	Internal Dimensions		
	Height (cm)	Width (cm)	Depth (cm)
A	12.5	17.5	49.2
B	15.9	21.0	49.2
C	12.5	35.2	49.2
D	18.9	26.3	49.2
E	15.9	42.3	49.2
F	27.8	35.2	49.2
G	18.9	52.9	49.2
H	32.1	42.3	49.2
H1	32.1	21.0	49.2
L	40.4	53.0	49.2
L2	38.5	53.0	49.2

*All dimensions are in cm and Tolerance - dimensions \pm 5%

Internal Dimensions in cm	Types of individual lockers in godrej safe deposit locker cabinets										
	A	B	2A	D	2B	4A	2D	4B	2B1	4D	4D1
	A	B	C	D	E	F	G	H	H1	L	L2
Height	12.5	15.9	12.5	18.9	15.9	27.8	18.9	32.1	32.1	40.4	38.5
Width	17.5	21.0	35.2	26.3	42.4	35.2	53.0	42.4	21.0	53.0	53.0
Depth	49.2	49.2	49.2	49.2	49.2	49.2	49.2	49.2	49.2	49.2	49.2
Type of S.D.L. Cabinet	Quantity of S. D. L. Cabinets										
1	66		6			3					
1A	90										
2		46			2			2	1		
2B		60									
3				28			2			2	
1C/45			45								
1F/21						21					
3D/40				40							
3G/20							20				
L2/10											10
1A/UB/18	18										
1A/UB/24	24										
1U/UB/30	30										
H/SP/12								12			
E/SP/24					24						
H1/SP/30									30		

*All dimensions are in cm and Tolerance - dimensions \pm 5%

Total qty. of S. D. Lockers (per unit)	Overall dimensions of S. D. L. Cabinet in cm. Hx W x D (approx.)	Net weight in kg. (approx.)
75	200 x 107.5 x 57.5	695
90	200 x 107.5 x 57.5	715
51	200 x 107.5 x 57.5	605
60	200 x 107.5 x 57.5	655
32	200 x 107.5 x 57.5	535
45	200 x 107.5 x 57.5	655
21	200 x 107.5 x 57.5	525
40	200 x 107.5 x 57.5	560
20	200 x 107.5 x 57.5	520
10	200 x 107.5 x 57.5	475
18	40 x 107.5 x 57.5	135
24	526 x 107.5 x 57.5	180
30	654 x 107.5 x 57.5	225

Tolerance: Weight +10 /-5 % or as per applicable standard, Dimensions: As per applicable standard

S.D.L. Type 1/75

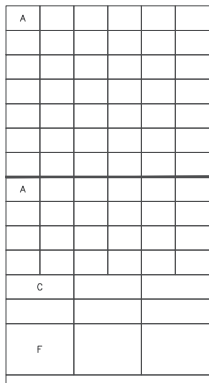

(66-A, 6-C, 3-F)
Std. S.D.L.

S.D.L. Type 1A/90

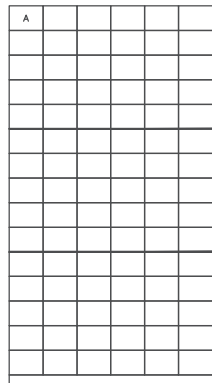

(90A)
Std. S.D.L.

S.D.L. Type 2A/51

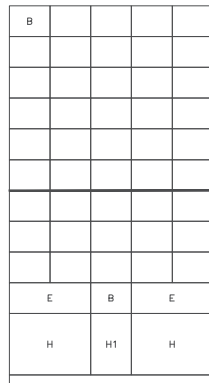

(46-B, 2-E, 1-H1)
Std. S.D.L.

S.D.L. Type 2B/60

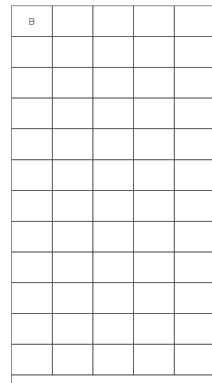

(60B)
Std. S.D.L.

S.D.L. Type 3/32

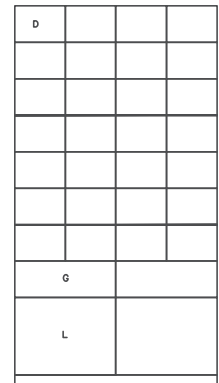

(28D, 22D, 2L)
Std. S.D.L.

S.D.L. Type 1C/45

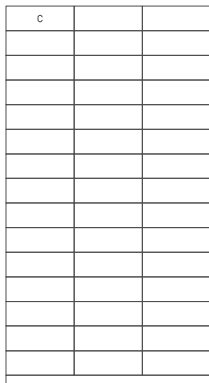

(45-C)
Std. S.D.L.

S.D.L. Type 1F/21

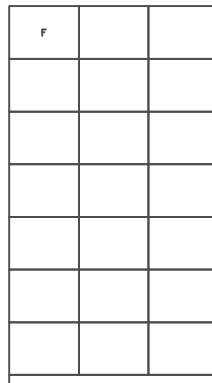

(21-F)
Std. S.D.L.

S.D.L. Type 3D/40

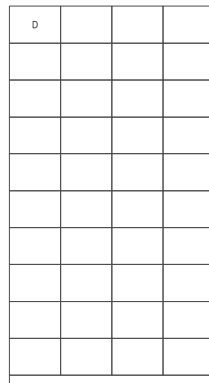

(40-D)
Std. S.D.L.

S.D.L. Type 3G/20

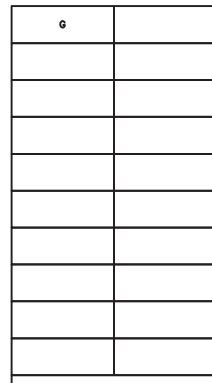

(20G)
Std. S.D.L.

S.D.L. Type L2/10

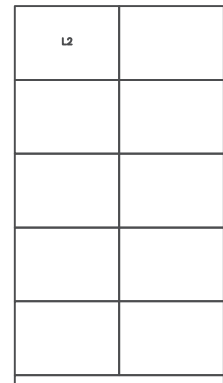

(10-L2)
Std. S.D.L.

S.D.L. Type H/SP/12

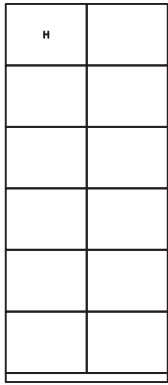

(12-H)
Non. Std. S.D.L.

S.D.L. Type 2B in 3 Parts

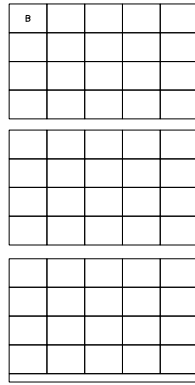

(60-B)
Std. S.D.L.

S.D.L. Type E/SP/24

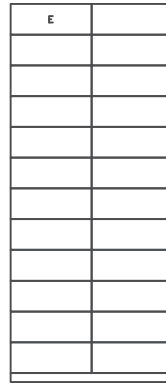

(24-E)
Non Std. S.D.L.

S.D.L. Type H1/SP/30

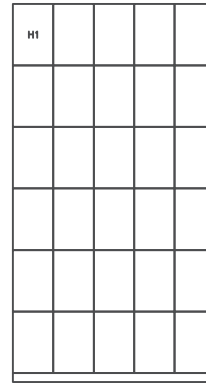

(30-H1)
Non Std. S.D.L.

1A/UB/24 (24-A)*

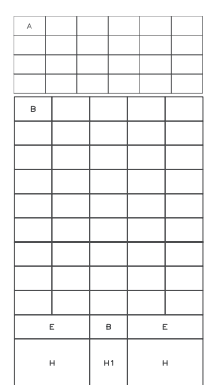

Std. S.D.L. Type-2
(46-B, 2-E, 2-H, 1-H1)

1A/UB/30 (30-A)*

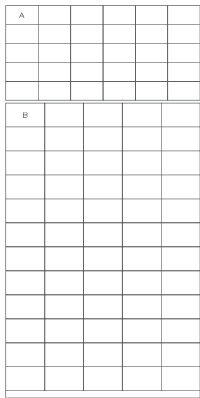

Std. S.D.L. Type-2B
(60-B)

1A/UB/24 (24-A)*

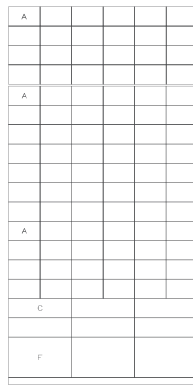

Std. S.D.L. Type-1
(66-A, 6-C, 3-F)

S.D.L. Type D/SP/10



(10-D)
Non. Std. S.D.L.**

***For utilising space on top of existing S.D.Ls. **For utilising corner space.**

Steel Sleepers

Moisture damage control



In regions of high humidity or in places where seepage and moisture are inevitable, it is essential to take that extra step to keep your customers' valuables and documents safe and free from moisture. Godrej Steel Sleepers prevent moisture present in walls and floors from damaging the locker cabinets and are also helpful in the event of flooding, leakage, or waterlogging, preventing water from reaching and damaging the contents of the locker.

Technical Specifications

Model	Height (cm)	Width (cm)	Depth (cm)	Weight
Steel sleepers for SDL	57.5	10	6.3	6.5 kg / PAIR

*All dimensions are in cm and Tolerance - dimensions ± 5%

Valuable Detection Equipments

Unparalleled precision and advanced technology,
that calibrates purity with matchless perfection.



AccuGold iEDX Series

X-Ray Fluorescence Spectroscopy Purity analysis of jewellery and precious metals

Unlock the brilliance within every ounce of gold with AccuGold iEDX Series, where precision meets innovation. Designed to redefine purity analysis, this cutting-edge X-Ray Fluorescence Spectroscopy device brings unparalleled accuracy to jewelry testing and precious metal authentication. Whether you're a jeweler safeguarding quality, a bank ensuring secure transactions, or a hallmarking center striving for regulatory excellence, ACCUGOLD 1000 transforms the way you measure, authenticate, and analyze gold. With its non-destructive testing, rapid analysis, and user-friendly operation, it's not just a tool—it's your partner in trust and reliability. Experience gold analysis like never before, with results you can see and trust.



AERB Certified



What is X-Ray Fluorescence ?

XRF (X-Ray Fluorescence spectroscopy)

X-ray fluorescence spectroscopy is a quantitative and qualitative analytical tool for elemental composition of a material by examining x-ray in the material and detecting x-ray generated when excitation of orbital electron.

X-ray
 $K\alpha = E_1 - E_0$
 $K\beta = E_2 - E_0$

Energy
 Examination by X-ray tube

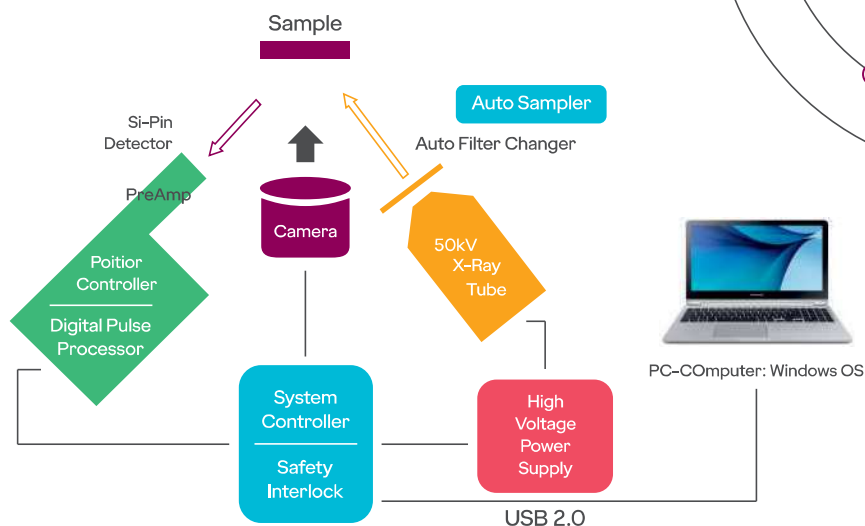
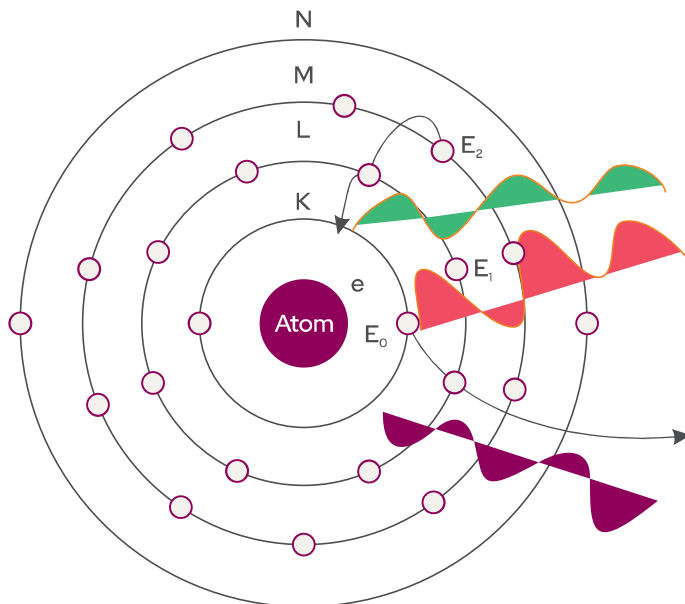

Advantages of accugold

ACCUGOLD 1000 offers several significant advantages for gold analysis, especially when compared to traditional methods like fireassay. Here's a breakdown of the key benefits:



Non-destructive testing



Rapid analysis



Increased precision with extended measurement



Improved trueness with calibration:



Ability to analyze unknown samples:



Small spot analysis for homogeneity check:



Reliable results for gold-coated materials:



User-friendly operation

Powered by high resolution semiconductor detector

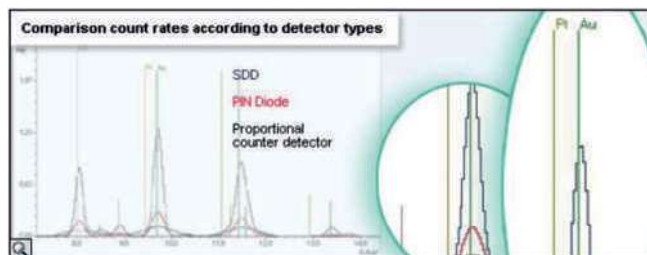
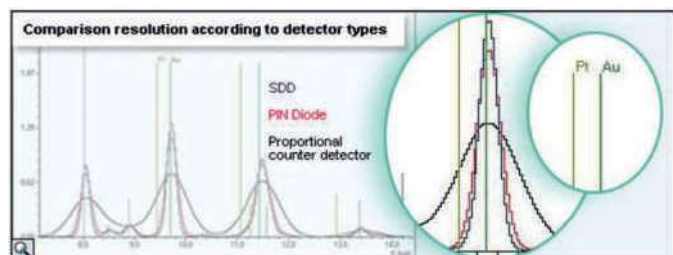



Jewelry Retailers and Manufacturers

- Gold and Precious Metal Authentication
- Quality Control
- Alloy Analysis
- Counterfeit Detection



Hallmarking Centers

- Regulatory Compliance
- Streamlined Processes



Banks

- Valuation of Precious Metals
- Secure Transactions
- Fraud Prevention



Customs Authorities



- Border Security
- Regulation Enforcement.
- Speed and Efficiency



Coin Mints

- Metal Composition Analysis
- Quality Assurance

Specification

Product			
Model	iEDX-100AC	iEDX-100RA	iEDX-100RS
No. of Elements Testing	Elements range from Titanium (22) to Uranium (92) – up to 15 elements simultaneously	Elements range from Titanium (22) to Uranium (92) – up to 22 elements simultaneously	Elements range from Titanium (22) to Uranium (92) – up to 32 elements simultaneously
Detector Type	Silicon Pin	Silicon Pin	Silicon Drift (SDD)
Collimator	2.0 mm	5x Changeable: 0.2, 0.7, 1.0, 1.5, 2.0 (mm)	5x Changeable: 0.2, 0.7, 1.0, 1.5, 2.0 (mm)
Power supply and Consumption	AC 230V, 50Hz, Max 235W	AC 230V, 50Hz, Max 235W	AC 230V, 50Hz, Max 235W
Instrument dimensions WxDxH in mm	450 (W) x 530 (D) x 380 (H) mm	420 (W) x 550 (D) x 450 (H) mm	420 (W) x 550 (D) x 450 (H) mm
Instrument weight in kg	Approx. 40 kg	Approx. 45 kg	Approx. 45 kg
Utility	Banks, Small Retail Stores,	Retail Stores, Small Hallmarking centers, Small Assaying centers	Hallmarking centers, jewelry manufacturing, Assaying centers, Refineries

Currency Counting Machine

Ensure every note counts with precision and speed. Our Currency Counting Machine delivers accuracy, efficiency, and reliability, making cash management effortless. Designed for businesses that value time and security, it detects counterfeit notes, sorts denominations, and streamlines your workflow—all with a seamless user experience. Count smarter, work faster.

Crusader Lite

Every note counted and checked.

The problem of counterfeit notes has risen in the past few years, affecting the profits of commercial establishments. Godrej Security Solutions presents Crusader Lite, which helps authenticate and count notes, with high accuracy.



Specifications

Counting notes (pieces/min)	1000
Counterfeit detection technology	UV, MG
Hopper capacity	300 notes
Stacker capacity	200 notes
Size range of note	Min: 5 cm x 10 cm Max: 9 cm x 19 cm
Power supply	90 ~ 240 V 50/60 Hz
Power consumption	75 W
Dimension	29.2 cm x 24 cm x 17.8 cm
Gross weight	6 kg

*Counting should not be done continuously for more than 20 minutes to avoid overheating

Valumatic

This machine authenticates currency, differentiates between denominations, counts them and calculates the total value.

Ensure every note counts with precision and speed. Our Currency Counting Machine delivers accuracy, efficiency, and reliability, making cash management effortless. Designed for businesses that value time and security, it detects counterfeit notes, sorts denominations, and streamlines your workflow—all with a seamless user experience. Count smarter, work faster.



Specifications

Dimensions	27 cm(W) x 24.5 cm(D) x 28.8 cm(H)
Weight	6.5 kg
No of Pockets	1 pocket
Hopper Capacity	300 notes
Stacker Capacity	200 notes
Pre-set Batch Number	1-200
Display Type	TFT colour LCD display 320 x 480 pixels
Detection Sensors	Dual CIS, MG, UV, IR
Modes of Operation	CNT (Piece Count), SDC (Single Denomination Count), MDC (Mixed Denomination Count), MULT (Mixed Currencies)
Interface	RS232C port (Printer), RJ11 port (External Display), USB port
Counting Speed	800/1000/1200 notes/min
Banknote Size Range	W: 11 ~ 19 cm, H: 5~ 9 cm
Banknote Thickness Range	0.075 ~ 0.15 mm
Multiple Currencies Support	10 currencies
Power Requirements	100~240 VAC, 50-60 Hz
Power Consumption	<80W
Operational Requirements	10-40°C / 0-85 RH

*Counting should not be done continuously for more than 20 minutes to avoid overheating

Countmatic

High function, friction type currency counter that provides currency authentication at a speed of 1000 notes per minute.

Designed aesthetically with latest technology, keeping customer convenience and satisfaction in mind, Godrej Count Matic is the preferred choice for a smooth, fast and reliable processing of notes. Godrej Count Matic is a high function, friction type currency counter that provides currency authentication at a speed of 1000 notes per minute.



Specifications

Hopper capacity	150 notes
Stacker capacity	150 notes
Counting speed	1000 pcs/min
Display type	<ul style="list-style-type: none">- LCD (Count display: 4 digits, Batch display: 3 digits Total count / total value display: 6 digits)- LCD color changes to Red when detects fake note with error codes- Displays mode of operation
Dimension	16 cm x 24 cm x 29.5 cm (H x W x D)
Power supply	AC 230V \pm 10% 50 Hz
Power consumption	<80W
Types of notes	Loose
Size of countable Notes	5 cm x 10 cm - 16.6 cm x 10 cm
Thickness of countable notes	0.075 mm - 0.15 mm
Gross weight	6.5 kg

*Counting should not be done continuously for more than 20 minutes to avoid overheating